



**WIRELESS COMMUNICATION SYSTEM  
WACO WM868**

**WM868-R4-LP-H**

*Revision 2.0*

# Contents

<b>1</b>	<b>Introduction</b>	<b>1</b>
1.1	WACO communication system	1
1.2	Module usage	1
1.3	Hardware features and power supplying	2
<b>2</b>	<b>Technical parameters overview</b>	<b>3</b>
<b>3</b>	<b>Configuration of the WM868-R4-LP-H module</b>	<b>4</b>
3.1	Configuration of the module with using of the configuration cable	4
3.1.1	Connecting of module to computer	4
3.1.2	Using of „PuTTY” freeware program for configuration	5
3.1.3	General rules for configuration of the module by configuration cable	6
3.2	Configuration of the module via radio	6
3.2.1	Using of „RFAN 3.x” program for the module configuration via radio	6
3.2.2	Connection of WACO communication GateWay to computer	7
3.2.3	General rules for configuration via radio	7
3.2.4	Remote configuration with using of RFAN 3.x Analyzer in steps	8
3.3	USB-CMOS converter driver installation	9
3.4	„USB GateWay” and „USB-IRDA” driver installation	10
3.4.1	How to disable driver signature enforcement in Windows 8 system	11
3.4.2	How to disable driver signature enforcement in Windows 10 system	12
3.4.3	Support of older OS Windows versions and OS Linux support	12
3.5	Setting of WM868-R4-LP-H module parameters by configuration cable	13
3.5.1	List of WM868-R4-LP-H module configuration parameters and commands	13
3.5.2	„Configuration” group of commands for writing of configuration and reset	14
3.5.3	Commands for settings of radio-frequency subsystem	14
3.5.4	Commands for setting of addressing in virtual bus	17
3.5.5	Commands for setting of RS-485 interface	18
3.5.6	Setting of test broadcasting	19
3.5.7	Special commands for module activation and diagnostics	19
3.5.8	Module current status statement	19
3.6	Setting of WM868-R4-LP-H module parameters via radio	21
3.6.1	Overview of module configuration parameters	22
3.7	Structure of module data messages	23
<b>4</b>	<b>Operational conditions</b>	<b>24</b>
4.1	General operational risks	24
4.1.1	Risk of mechanical damage	24
4.1.2	Risk of electrical damage	24
4.2	The condition of modules on delivery	24
4.3	Modules storage	24
4.4	Safety precautions	25
4.5	Environmental protection and recycling	25
4.6	WM868-R4-LP-H module installation	25
4.7	Module replacement	26
4.8	The module dismantling	26
4.9	Functional check of the module	26
4.10	Operation of the WM868-R4-LP-H module	26
<b>5</b>	<b>Troubleshooting</b>	<b>27</b>
5.1	Possible causes of module failures	27
5.1.1	Power supplying failures	27
5.1.2	System failures	27
5.1.3	Transmitter and receiver failures	28
5.1.4	Data bus failures	29
5.2	Troubleshooting procedure	29
<b>6</b>	<b>Additional information</b>	<b>31</b>

## List of Tables

1	Overview of WM868-R4-LP-H module technical parameters . . . . .	3
2	Overview of WM868-R4-LP-H module configuration parameters . . . . .	22

## List of Figures

1	Principle of transparent data transfer in WACO RF-network . . . . .	1
2	View of the WM868-R4-LP-H module . . . . .	2
3	Appearance of the USB-CMOS converter in Windows „Device Manager” . . . . .	4
4	Configuration via USB port of computer . . . . .	5
5	Terminal setting for serial line communication . . . . .	5
6	Open terminal window for module configuration via serial line . . . . .	6
7	Principle of local configuration via radio . . . . .	6
8	Principle of remote configuration via radio . . . . .	7
9	Appearance of WACO USB GateWay in the MS Windows „Device Manager” . . . . .	7
10	Entering of devices and variables into the remote configuration window . . . . .	8
11	Progress of getting values of preselected variables of the module by using of „GET” command . . . . .	9
12	Appearance of converter without driver in the Windows „Device Manager” table . . . . .	10
13	Displaying of the device without driver in ”Device Manager” window . . . . .	10
14	Manual selection of the driver file from a folder . . . . .	11
15	USB driver installation . . . . .	11
16	Principle of addressing in the WACO „Virtual BUS” application . . . . .	17
17	Setting of module System time via radio . . . . .	21
18	Table of all WM868-R4-LP-H module variables displayed by RFAN 3.x analyzer . . . . .	21
19	WACO SLRF protocol structure . . . . .	23
20	Structure of WACO system data packet . . . . .	23
21	Detailed view of WM868-R4-LP-H module . . . . .	25

# 1 Introduction

This document describes features, parameters and setting possibilities of the WM868-R4-LP-H module, which is used for transparent data transfer among remote segments of virtual bus through the WACO radio-frequency network.

## 1.1 WACO communication system

**WACO** (Wireless Automatic Collector) is radio frequency (RF) communication system intended especially for the remote reading of consumption meters (smart metering area), automatic data collection from sensors (telemetry area), and bi-directional data transfer among control, sensing and actuating elements in automatic control systems (industrial automation area). Installed WACO radio-frequency elements create local radio network covering object of interest (flat, house, building, compound...) or required area (street, city...).

**WACO RF network** has a „mesh” type of topology, where in reach of each radio element there could be placed several other network elements that could operate also as repeaters of received signal. In this kind of network there are typically several possible communication paths between the central point and other single elements of the network. WACO network communication protocol was designed to provide a **maximum data transmission reliability and redundancy** with using of multiple communication paths, but at the same time the network is protected against circularity and multiplication of messages by sophisticated algorithms so that the network keeps also a **high performance** even with high number of radio elements working in one network.

WACO communication protocol was designed in compliance with a telecommunication standard **ISO/OSI model** that ensures a high variability of supported applications.

WACO radio-frequency devices (hereinafter „radio modules”) are equipped with **various types of input/output interfaces** that enables integration of various connected device (meters, sensors, actors...) into one network.

WACO communication system includes also special communication devices - **WACO GateWays**, that enable receiving of radio messages from the local WACO RF-network and transfer them to the local or remote computer through the serial line or Internet and (in inverse direction) receiving messages from the serial line/Internet and broadcast them into „its” RF-network.

## 1.2 Module usage

As it is clear from the functionality description below, the WM868-R4-LP-H module can be used in applications of M-Bus/RS-485/RS-232 data-bus systems, that are commonly deployed in industrial automation as well as in the area of remote reading of meters and sensors („metering”, „smart metering”). The WM868-R4-LP-H module serves for data transfer among WACO RF-network and any device on the local 2-wire data-bus according to the RS-485 standard specifications. Principle of module usage in M-Bus/RS-485 data-bus systems is shown in the figure 1.

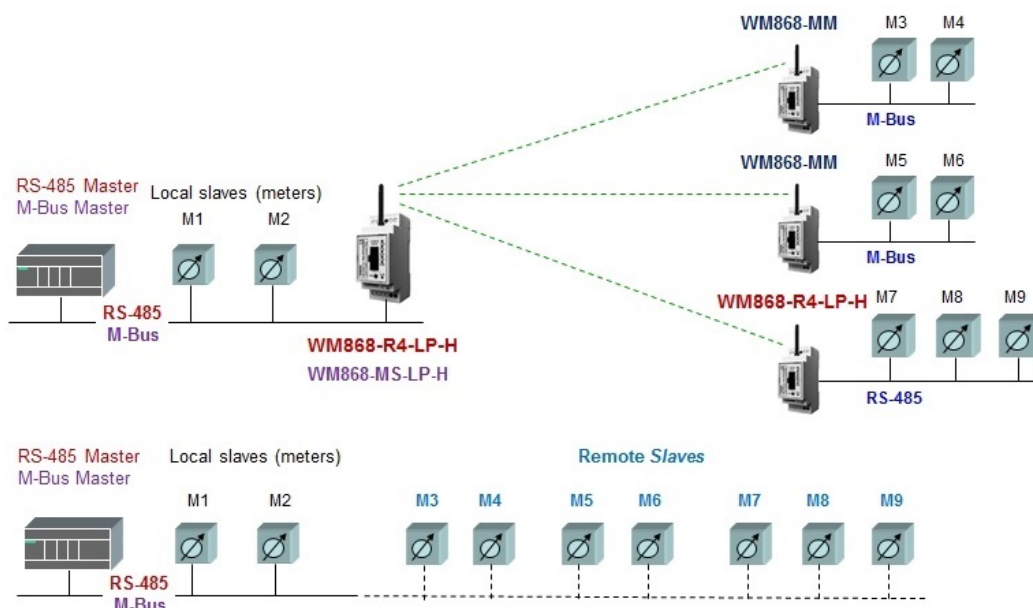

Figure 1: Principle of transparent data transfer in WACO RF-network

As evident from the picture, the WM868-R4-LP-H module ensures communication between "its" device connected through the RS-485 data-bus with other segment of WACO virtual bus. The module can be used either in main segment of virtual bus (if bus control unit - „master” - is equipped with RS-485 interface), or in any remote segment of virtual bus. In both cases the module receives messages from its local „wired” bus and resend them through the WACO RF-network, and (in reverse direction) receives messages from WACO RF-network and resend them to the local „wired” bus.

If virtual bus control unit („master”) is equipped with RS-485 interface and the WM868-R4-LP-H module serves for connection of main bus segment with remote segments, the module receives requests from master through the „wired” bus and resends the requests to the WACO RF-network. RF-modules in remote bus segments receive these requests and resend them to their local buses. Slave devices transmit their answers through the local „wired” buses and local RF-modules resend them to WACO RF-network. The WM868-R4-LP-H module at main segment receives the answers from RF-network and resend them to „master” through the local main bus.

Data transfer is going on in the „Virtual BUS” application (port "32" in WACO network protocol), where the data messages are transferred totally transparently, without any conversion. Even it is possible to interconnect several remote bus segments with different physical type (e.g. RS-232, M-Bus and RS-485 types, as depicted in the figure 1), all devices („Master” as well as all „Slaves”) on the united virtual bus must use same communication protocol (same data structure) to „understand” each other. In metering area there are commonly used M-Bus and IEC 62056 (formerly DLMS) protocols, frequently used data protocols in industrial automation are Modbus, S-bus and similar data formats.

The „Slave” devices installed on the remote bus-segments (connected through the WACO RF-network) are accessible for „Master” device same way, as local devices (that are on the same segment as „Master”). From the logical structure point of view all physical segments are united together into the one large data-bus as depicted in the lower part of the figure 1.

### 1.3 Hardware features and power supplying

The module is enclosed in a plastic casing adapted for mounting on a DIN-rail. The box has a standard „circuit breaker” profile and width of two standard DIN-modules. The module is equipped with a **RS-485 data bus screw-on terminal** with four clamps and with **DIP switch** for engaging of either 100 Ω terminating resistor (for standard cable impedance), or alternative 1000 Ω terminating resistor (for non-standard installations). DIP switch should be engaged in that case, if the WM868-R4-LP-H module is connected at the beginning/end of the bus.

The individual clamps have following purpose:

- - clamp **”GND”** - for interconnection of all „grounds” (for power supplying or potential equalization purposes);
- - clamp **”A/+”** - for attaching of ”A” conductor of the RS-485 bus;
- - clamp **”B/-”** - for attaching of ”B” conductor of the RS-485 bus;
- - clamp **”5V”** - can be used for supplying of connected sensor with 5 V/100 mA power;

The module needs an external power supply 24V DC. For connecting of the power supply there is a screw-on terminal with marked voltage polarity. Power supplying must follow all the safety requirements according to the appropriate standards. Maximum current consumption of the module (for voltage of 24 V) is up to 50 mA, the module is protected on the power supply input by reversible fuse with release current of 300 mA.

The module cannot be used in exteriors without additional covering. External appearance of the WM868-R4-LP-H module is shown in the Figure 2.



Figure 2: View of the WM868-R4-LP-H module

## 2 Technical parameters overview

Overview of WM868-R4-LP-H module technical parameters is shown in the Table 1 below.

Table 1: Overview of WM868-R4-LP-H module technical parameters

<b>RF subsystem parameters</b>		
Frequency band	868,0 - 868,6	MHz
Modulation	FSK	
Number of channels	3	
Bandwidth	200	kHz
Transmitting power	25	mW
Receiver sensitivity	106	dBm
Communication protocol	WACO	
Transmission speed	38400	Baud
Antenna connector	SMA female	
Antenna characteristic impedance	50	$\Omega$
<b>Configuration interface RS232</b>		
Transmission speed	19200	Baud
Operation mode	asynchronous	
Transmission parameters	8 data bits, 1 stop bit, none parity	
Signal level	TTL/CMOS	
<b>Data interface</b>		
Interface type	RS-485	("A/+" and "B/-" clamps)
Transmission speed	300 ÷ 115200	Baud
Operation mode	asynchronous	
Transmission parameters (default)	8 data bits, 1 stop bit, none parity	
Signal level	by CCITT V.11	
Auxiliary "GRD" clamp	„ground"	grounds interconnection
Auxiliary "5V" clamp	+5 V/0,1A	sensor supplying
<b>Power supplying</b>		
External power supply	24	V $\pm$ 10%
Input power	4	W
<b>Weight and dimensions</b>		
Width	35	mm
Height	90	mm
Depth	58	mm
Weight	cca 150	g
DIN casing size	2 modules	
<b>Storage and installation conditions</b>		
Installation environment (by ČSN 33 2000-3)	normal AA6, AB4, A4	
Operation temperature range	(-20 ÷ 50)	$^{\circ}$ C
Storage temperature range	(0 ÷ 70)	$^{\circ}$ C
Relative humidity	90	% (w/o condensation)
Degree of protection	IP20	
<b>Signaling and control</b>		
Power signaling	"PWR"	green LED
Signaling of RF transmission	"TXA"	yellow LED
Signaling of RF reception	"RXA"	yellow LED
Signaling of bus transmission 1	"TXR"	yellow LED
Signaling of bus reception	"RXR"	yellow LED
Signaling of RF signal collision	"ALR"	red LED
System restart button	"RES"	



## 3 Configuration of the WM868-R4-LP-H module

Configuration parameters of the WM868-R4-LP-H module can be displayed and changed from the common computer (PC) by one of these methods:

- with using of „**USB-CMOS**” converter and configuration cable connected to the module
- wirelessly, with using of WM868-RFU radio-frequency communication gateway

Technique of interconnection of the module with configuration computer and general rules of configuration are described in detail in the section 3.1 „Configuration of the module with using of the configuration cable”. The description and meaning of all configuration parameters that can be checked and changed by cable can be found in the section 3.5 „Setting of WM868-R4-LP-H parameters via configuration cable”. Description of interconnection of the WM868-RFU RF-communication gateway with computer and general rules of configuration **via radio** are described in the section 3.2 „Configuration of the module via radio”. The description and meaning of the parameters that can be changed via radio can be found in the section 3.6 „Setting of WM868-R4-LP-H parameters via radio”.

### 3.1 Configuration of the module with using of the configuration cable

Configuration of the module can be performed by using of any PC with MS Windows or Linux operating systems interconnected by configuration data cable. The module’s communication interface is of RS-232 (COM) type with CMOS signal level. The ”CONFIG CMOS” configuration connector is placed on the module’s front panel.

#### 3.1.1 Connecting of module to computer

Configuration can be performed by using of common USB port of the computer. For the interconnection with a USB port of computer it is necessary to use an manufacturer’s original configuration cable with „USB-CMOS” converter (see Figure 4). This converter creates a virtual serial port through the USB interface and adapts voltage levels of the module’s configuration port to the standard USB port of common PC. So as to be able to create a virtual serial connection via USB interface, there must be a relevant driver installed in the computer operation system. After the „USB-CMOS” converter is connected to computer for the first time, operating system will find and install appropriate generic driver of „USB Serial Device” category automatically. After driver installation is completed, the device will appear in the „Ports (COM and LPT)” section of the „Device Manger” window as „USB Serial Device (COMx)” (see figure 3).

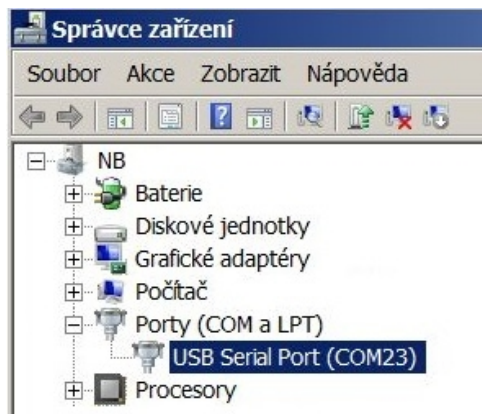

Figure 3: Appearance of the USB-CMOS converter in Windows „Device Manager”

As some of the older MS Windows versions do not support a generic driver for USB serial ports, the automatic installation of the driver could fail (system reports „Driver software installation failure”, or „driver not found“). In this case there is necessary to install the driver manually, following the steps in paragraph 3.3 „Installation of USB-CMOS converter driver”.

Insert USB-CMOS converter to the USB port of computer. Connect configuration cable to the „CONFIG CMOS” port on the module’s front panel. Thus, the computer is connected with the module and ready for performing any changes in configuration (see figure 4 „Configuration via USB port of computer”).



Figure 4: Configuration via USB port of computer

### 3.1.2 Using of „PuTTY” freeware program for configuration

The module configuration can be done with using of any suitable program for the serial line communication. The description below is relevant for the open-source software „PuTTY” that is available for free on [www.putty.org](http://www.putty.org).

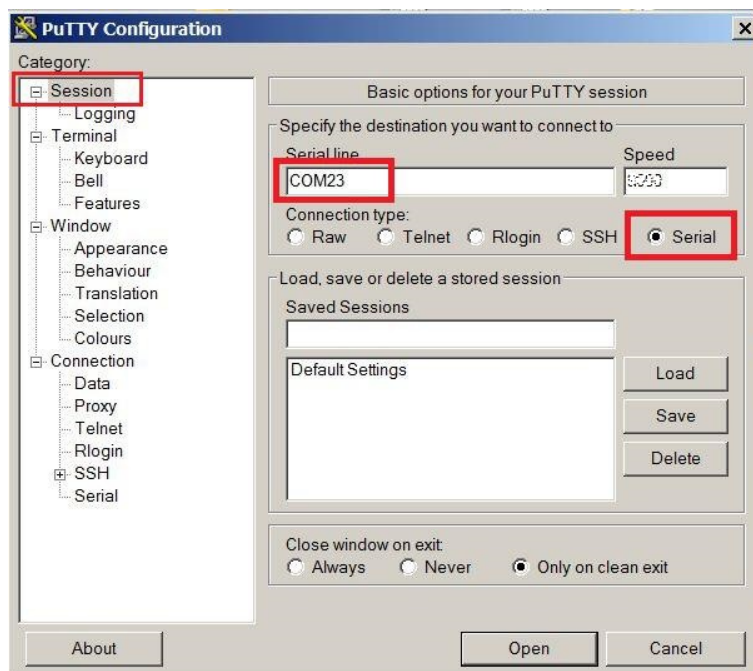

Figure 5: Terminal setting for serial line communication

„PuTTY” software runs after clicking on the downloaded file „putty.exe“. There will open a window of the terminal communication (see Figure 5). For switching the program into the serial line communication, choose „Serial” option of the connection type in the „Session” tab.

Check (or set up) the communication speed („Speed”) to 19200 bits/s and then enter into the „Serial line“ tab the number of the serial port that the system automatically assigned to the virtual port at the moment of interconnection module to the computer. The number of the serial port can be found in OS Windows by using of „Device Manager” (Control Panel/System and Maintenance/Device manager) by clicking on „Ports (COM & LPT)” where the numbers of ports appear (e.g. „COM23” - see figure 3).

Click on „Open” button in „PuTTY” program and open the terminal window. After pressing of „ENTER” key there will appear a command prompt „sysmon” which announces that the module is ready to be configured (see figure 6).



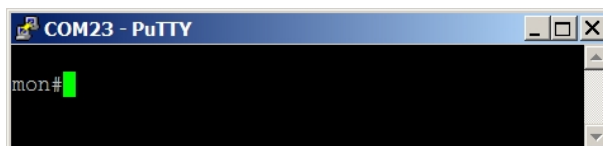

Figure 6: Open terminal window for module configuration via serial line

### 3.1.3 General rules for configuration of the module by configuration cable

Activate the terminal window for the configuration via the configuration cable according to the instructions above. These general rules are valid for entering commands into the command line:

- the command must be entered only when a prompt for command appears in front of the cursor mark (colored or flashing little square); the prompt is either „sysmon” or „mon” format (see figure 6);
- it is possible to enter only one command each time;
- the command could be entered in an alphanumeric character (or several characters);
- the command is sent to device by clicking on „ENTER” key. After the command being carried out, the prompt will appear again and it is ready for a new command to be entered. In case the command fails to execute, there will appear an error report;
- check the execution of the command by displaying of the list of configuration parameters which appears by entering ”show” or ”/” and pressing on „ENTER” key;
- to display a summary of configuration commands and their parameters („HELP”), enter ”?” (question mark), or ”/?” and press „ENTER” key;
- when entering characters, distinguish strictly the capital and small letters (according to the documentation or „HELP”);
- Do not enter other characters than those listed in „HELP“ or in the documentation, otherwise you would be risking the unwanted command enter that might be the same as the ones used for manufacturer settings, diagnostics or service and repair.

## 3.2 Configuration of the module via radio

Remote configuration via radio signal is proceeded via special WACO radio messages (queries and commands) that will query the module to get current settings of its individual parameters, or (in case of need) will send a command to change these parameters.

It is possible to configure the module locally from the convenient spot within module radio range (for example from PC with connected gateway WM868-RFU - see figure 7), or to configure the module remotely from a remote computer via local gateway WM868-RFE (WACO Ethernet Gateway) or WM868-RFG (WACO GSM Gateway) as depicted in the figure 8.

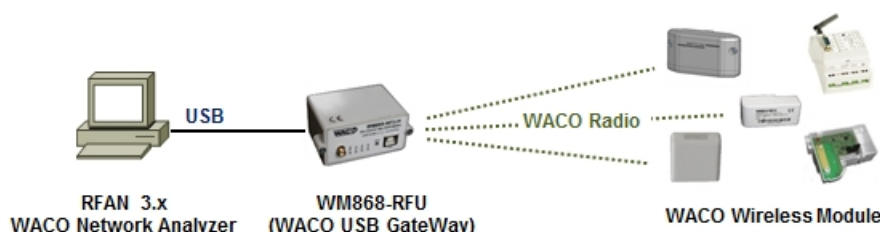

Figure 7: Principle of local configuration via radio

In both cases there must be direct radio visibility between the configured module and the communication gateway – it is totally **impossible to configure the WM868-SI2/SI2-H modules via repeater**.

### 3.2.1 Using of „RFAN 3.x” program for the module configuration via radio

The universal tool for the configuration of WACO family modules is „WACO Radiofrequency Analyzer RFAN 3.x” (hereinafter „analyzer”) that can be used for setting up of all remotely configurable parameters of the module. Analyzer is a computer program written in Java language, which can be installed to any common PC (desktop, laptop, tablet...) with operating system with Java Virtual Machine support. Functionality of RFAN 3.x analyzer

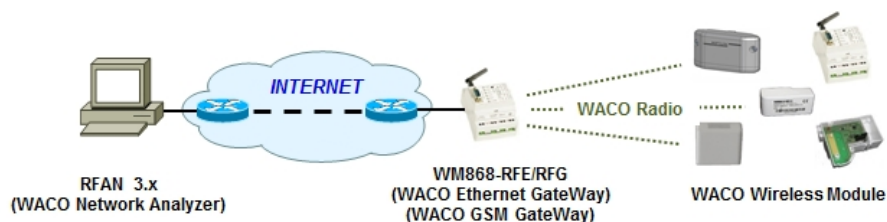

Figure 8: Principle of remote configuration via radio

is described in detail in the „WACO RFAN 3.x – Software description and configuration” manual, where there are also described in details the steps how to find out current setting of a particular parameter and how to change the setting.

Purpose and importance of all configuration parameters is described in the next part of the document. Overview of all parameters that can be configured via radio can be found in the section 3.6 „Setting of module parameters via radio”. General principles and technique of radio configuration are described in details in section 3.2.3 „General rules of configuration via radio”.

### 3.2.2 Connection of WACO communication GateWay to computer

WACO Communication Gateway is the device intended for communication among a WACO supported software application (e.g. RFAN 3.x) and all subordinate elements of WACO wireless network. The GateWay can be connected to the computer with the RFAN 3.x application directly (through a convenient port of PC) or indirectly through the IP network. „WACO USB GateWay” (with USB support) as well as „WACO Ethernet GateWay” (with ethernet support) can be connected directly, while „WACO Ethernet GateWay”, and „WACO GSM GateWay” can be connected indirectly, what means that the GateWay is not connected to the computer with analyzer, but it is connected to the remote Ethernet/IP port of the IP-network (Internet) anywhere over the world provided that there is an IP-connection between the computer and the GateWay (see figure 8).

Connect WM868-RFU (WACO USB GateWay) to the USB port of computer with RFAN 3.x program. The module is powered from the USB port of computer, so it automatically goes „on” and three virtual serial ports are activated: one for data connection, one for configuration and one for possible firmware upgrade. The device appears in the „Other devices” section of the „Device manager” window and its virtual serial ports appear in the „Ports (COM and LPT)” section as depicted in the figure 9.

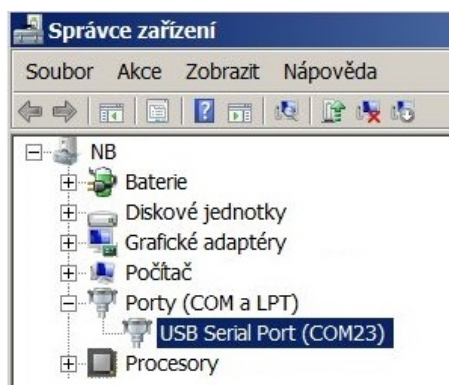

Figure 9: Appearance of WACO USB GateWay in the MS Windows „Device Manager”

If there is no appropriate driver with support of multiple virtual serial ports over USB installed in the computer, it is not possible to select serial port in RFAN 3.x setting (no serial port is available for choice). In this case the virtual serial ports appear in the „Other devices” section of „Device Manager” and it is necessary to install appropriate driver according to the instructions stated in part 3.4 „USB GateWay and USB-IRDA driver installation”.

### 3.2.3 General rules for configuration via radio

RFAN 3.x Analyzer enables remote configuration of WACO radio devices. This function is accessible in folder „Remote Config”. The principles of the configuration tools are following:

- select the device to be configured (or read current configuration)

- select variable that should be changed (or read)
- launch function „GET” for reading current value, or „SET” for changing of value or „WALK” for reading of all values

When performing of configuration (i. e. making changes or just reading of current settings) keep these general rules:

1. the configuration cannot be made in bulk, there must be always only one device chosen that will be configured;
2. each single variable is set up/queried by a single command/query;
3. there is a possibility to define more configured/queried variables within the tool and run their configuration/query by one click as a sequence, nevertheless, the configuration/querying of each variable is processed individually, one after another, in the order in which the sequence was set up;
4. in case the „WALK” command for querying the current status of all module’s variables is used, the analyzer starts dispatching queries that will ask the individual variables step by step;
5. when a „SET” command was sent to device, the device will proceed the command (or not – see rule 6. and 7.) and turns back a value that is really valid after the command execution;
6. if a „SET” command was sent to a variable, that is of „Read Only” character (for example type of the device, or serial number), then the device will not process the command and turns back current value of the variable;
7. if a „SET” command contains such value that is out of the defined range of values of the variable, or that has no sense, then the device either not process the command or change the variable to closest possible value. In any case, the device will send back the value which is really set after proceeding the command;
8. if a „GET”/„SET” command contains variable that is not implemented in the particular device (the device „doesn’t recognize” the variable), then the device turns back „null” value which appears in the analyzer as not accomplished command/query.

### 3.2.4 Remote configuration with using of RFAN 3.x Analyzer in steps

The configuration could be performed in „Remote configuration” mode (fold „Remote Config”). Add the device that should be configured into the left section of the screen by using of „Add RF Address” option of the section context menu (displayed by right-click). The new „Add RF Address” window (form) will open, where there it is necessary to fill in:

- fill device RF address in hexadecimal format marked „0x” (for example „0xffffef6d”)
- tick the „Wake On Radio” option for battery powered modules
- write any description into the „Description” field for better module recognition
- by clicking to „Add” button add the device into the configuration list.

Entering of a device into the „RF Address” window is depicted in the left part of the figure 10.

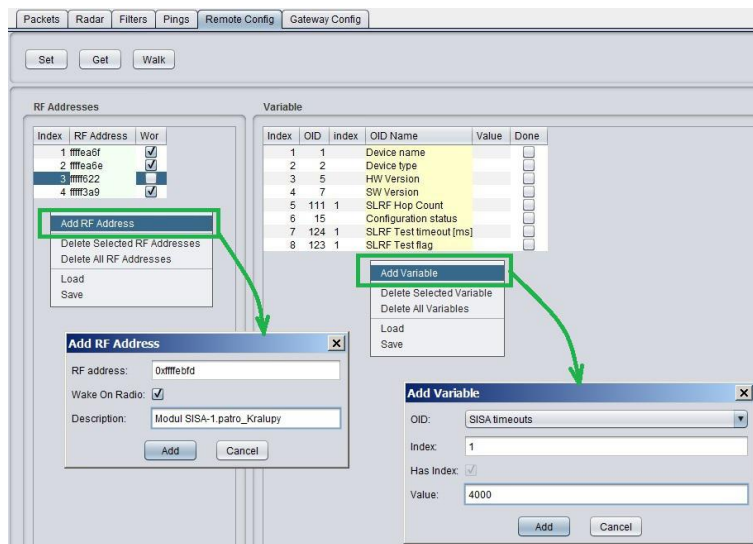

Figure 10: Entering of devices and variables into the remote configuration window

Create the sequence of variables that should be configured (query or set) by clicking on „Add Variable” option in the right section context menu. The new „Add Variable” window (form) will open, where there it is necessary to edit following fields:

- into OID field (Object ID) select a name of variable that should be added in the sequence

- in case the variable has an index, put the index number in (information box „Has Index“ is ticked and „Index“ box is editable);
- set up required value of the variable into the „Value“ field. If the variable will be just read (checked its current value), leave the field blank. Those variables, that have „Read only“ status (invariable constants, measured values) will have the „Value“ box uneditable;
- by clicking on „Add“ button add a variable to the sequence of variables used for configuration.

Entering of a variable into the „Variables“ window is depicted in the right part of the figure 10.

Command **GET** (reading the current variable value), **SET** (setting up the required variable value), or **WALK** (reading the current status of all variables) will be done only for one chosen device from the list of devices in „**RF Address**“ tab. Run the required command by clicking on relevant button in the top of the screen. After the click, there will appear an information window in which a progress of getting/setting process of will be displayed. As the individual settings are performed, the „tick“ symbols in the „Done“ box appear item-by-item. The „Getting/Setting“ window will disappear after the all commands of the sequence are being accomplished, or after the expiration of the preset time limit (TimeOut). The current variable values are listed in the field „Value“ in the relevant row.



Figure 11: Progress of getting values of preselected variables of the module by using of „GET“ command

To avoid serious mistakes that can bring the module into paralyzed condition, numb for further communication, it is necessary to know the meaning of all modified variables of the device, including their mutual relations.

**Example:** If value of „SLRF Test Flag“ variable is set to „1“, the module will be preset to send test messages in period which is set up by variable „SLRF Test Timeout [ms]“. In this case the period is just 1 millisecond. The trouble will occur if the test broadcasting would be switch on. It is necessary to set some reasonable period (e.g. 5 second) first and just then switch test broadcasting „on“, otherwise the module would broadcast permanently and never be able to receive any other command.

When configuring battery powered modules, always use the „Wake-On-Radio“ (WOR) function. The function enables to „wake up“ the module with a special „waking“ radio signal from „hibernation“ mode (that means the mode in which the module is almost permanently) to the mode of active signal reception. Keep in mind that by „waking up“ of the particular required module the other modules, that are placed within the GateWay current radio range, will also be activated. Excessive activating of the module can cause the reduction of its battery life. To avoid the excessive „waking“ of many modules around the GateWay it is recommended to follow these instructions:

- do not change the parameters if it is not necessary for the module’s functionality;
- consider the succession of the configuration commands (or prepare them as a „template“);
- do not use command „WALK“ if not necessary - (reading of all module variables);
- find suitable place for the configuration, that is in a good reach of configured device.

We also recommend keeping the modules in closed boxes, shielded with aluminum foil (or in metal boxes) so the modules are protected from the excessive „waking up“ and their batteries won’t be damaged. When you do the preliminary configuration before mounting, always take out from the shielded box only the necessary number of modules. After their configuration, the modules should be placed back in the shielded box.

### 3.3 USB-CMOS converter driver installation

If the computer operation system failed in automatic installing of the driver for the „USB-CMOS“, it is necessary to install the driver manually. The relevant current driver can be found on a chip manufacturer’s (FTDI) webpages, namely in the „VCP Drivers“ (Virtual COM Ports) section.

[www.ftdichip.com/Drivers/VCP.htm](http://www.ftdichip.com/Drivers/VCP.htm)

In the „Currently Supported VCP Drivers“ table find a link to a driver relevant to your operating system. To download the file, click on a link in the table. After downloading the file (in .ZIP format) into any directory in your computer, unzip the file. It will create a new folder (directory) with a set of files (e.g. „CDM 2.08.24 WHQL Certified“).

Connect the converter „USB-CMOS“ to your computer and open a „Device Manager“ tool. The converter with the disabled driver will be displayed in the top right corner of the window as „Other Devices“ (see figure 13 left).

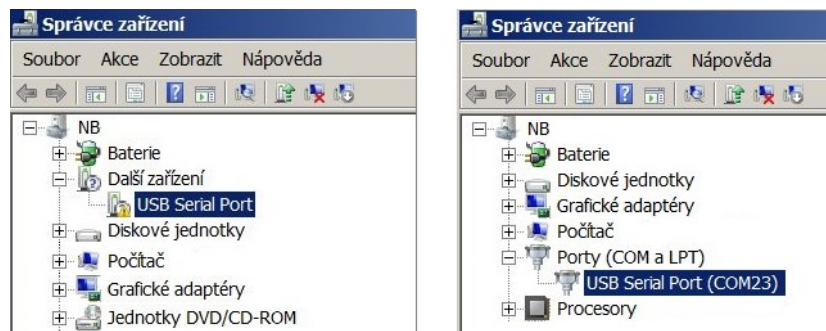

Figure 12: Appearance of converter without driver in the Windows „Device Manager“ table

Click by right mouse button on „USB Serial Port“ and choose „Update Driver Software“ option in the context menu. Choose „Find Driver in this computer“ option in the „Update Driver Software“ window. Use „Browse“ button to set up the path to the driver’s folder (directory) and then click on the „Next“ button. The driver installation process will launch. After the driver installation is completed, the standard „Installation Completed“ message will appear. After the installation the converter will appear in the „Ports (COM and LPT)“ section of the „Device Manager“ window (see figure 13 right).

### 3.4 „USB GateWay“ and „USB-IRDA“ driver installation

The driver „ugw3.inf“ intended for support of multiple virtual serial ports through the USB interface of a computer is a part of delivered installation pack. If your version of MS Windows operating system failed in automatic installation of a driver for connected „USB GateWay“ or „USB-IRDA“ device, make an installation of „ugw3.inf“ driver manually.

Connect the device to computer and open a window of „Device Manager“ tool. The device appears in the „Other device“ section in upper part of the window as „USB Serial port“ device (see figure 13 left).

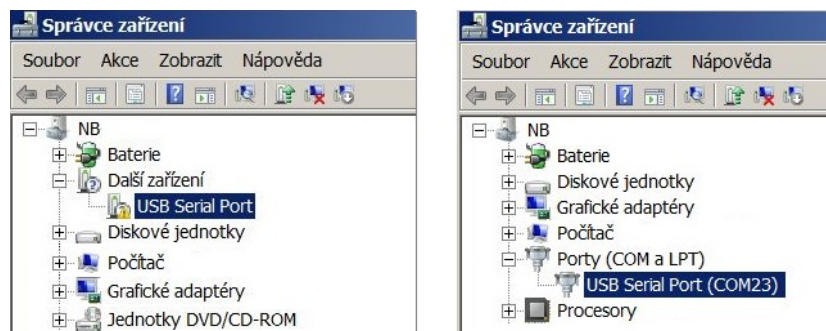

Figure 13: Displaying of the device without driver in ”Device Manager“ window

By right-clicking to „USB Serial port“ open the context menu and choose „Update driver software“ item. Click on „Find driver in this computer“ in the opened window. Click to „Select driver from the list“ and „Next“ in next window. After a new „Select device type from the following list“ window appears, select „Ports (CPM & LPT)“ in the window and click to „Next“ button (see figure 14 left). Choose „From disc“ in the next „Choose driver which you want to install“ window ( figure 14 right).

After that a new „Find file“ window appears. Set the folder with driver file in the „Browse“ tool, select „ugw3.inf“ file name that will appear in the window and click to „Open“ button (see figure 15 left). A new „Choose driver to be installed for the hardware“ window will appear, select „RFU Gateway Serial port“ item and click to „Next“ button (see figure 15 right).



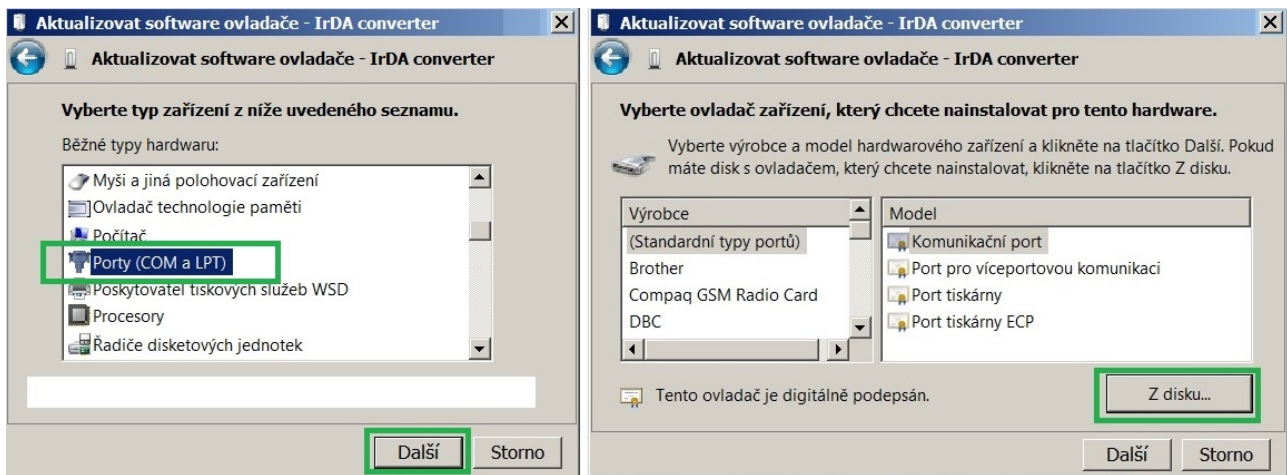

Figure 14: Manual selection of the driver file from a folder

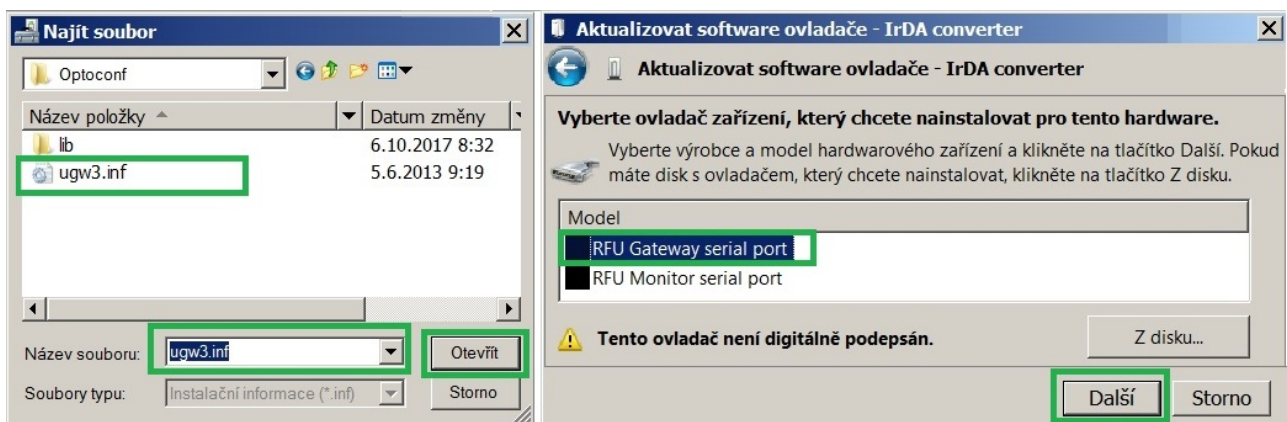

Figure 15: USB driver installation

A new „Driver software installation” window will appear with standard red „unknown driver producer” Windows system warning. Click to „Install the software anyway” option and the installation process will launch (\*). After the process is completed the system shows positive message „The driver was successfully installed” (or similar). The device will move to the „Ports (COM & LPT)” section of the „Device Manager” window (see figure 13 right).  
 (\*) If installing the driver into the Windows 8 or Windows 10 OS computer, it could be a security problem with the installation because the driver doesn't have a digital signature („unsigned driver“). In this case follow the instructions below.

### 3.4.1 How to disable driver signature enforcement in Windows 8 system

Enforcement of signed driver installation in Windows 8 can be disabled by following procedure:

- by pressing the „Windows + R” keys open the „Run” window;
- write a restart command ”shutdown.exe /r /o /f /t 00” into the „Open” editable field;
- choose „Troubleshoot” option in the „Choose an option” window that will pop-up;
- choose „Advanced options” in opened „Troubleshoot” window;
- choose „Windows Startup Settings” in opened „Advanced options” window and run „Restart”;
- during the system restart process a window „Advanced Boot Options” appears, choose „Disable Driver Signature Enforcement” option in this window;
- after launching the system install the driver according the above mentioned instructions.

Deactivation of the enforcement of signed driver function of the Windows 8 operating system is functional only until the next restart of the system.



### 3.4.2 How to disable driver signature enforcement in Windows 10 system

Enforcement of signed driver installation in Windows 10 can be switched-off by following procedure:

- click to „Windows” icon in left the bottom left corner of the screen and choose „Settings” icon;
- select „Update and security” in „Settings” window;
- select „Recovery” in next window’;
- select „Advanced startup” section in „Recovery” window and click to „Restart” button in the section;
- in a few seconds the new „Choose an option” screen appears; select „Troubleshoot” option;
- in next steps select „Advanced options” and „Startup repair” options and click to „Restart” button;
- in this step an instruction for entering of „BitLocker” recovery key could appear (depends on the system settings). This is a 64-character access key for data section of the user that can be used in case of loss of OS Windows password. The key can be found in the „Microsoft Account Settings” page, that can be displayed by clicking to „Windows” icon and „User” item of main Windows menu. To get to the account it is necessary to click to „Change account setting” and „Manage my Microsoft account” and log into the account by using of Microsoft user login/password. Select „Device” in main menu of the user account page and click to „Obtain BitLocker recovery key” in „Desktop” section and „Bitlocker” subsection. The new screen with recovery keys will open. Copy down the key that is valid for the required unit (according to the required unit identifier);
- after entering of the key the new screen with startup options will appear, select „Disable Driver Signature Enforcement” option from the list. The selection can be done with using of F1 - F10 keys, for selected option with order number „7” press key „F7”;
- after OS Windows restart perform the driver installation according to the above described procedure.

Deactivation of the enforcement of signed driver function of the Windows 10 operating system is functional only until the next restart of the system.

### 3.4.3 Support of older OS Windows versions and OS Linux support

Earlier MS Windows versions (Vista, Windows XP and older ones) do not support sufficiently the installation of multiple virtual serial ports onto one physical USB port and the current versions of „USB GateWay” and „USB-IRDA” devices cannot be connected to the computers with these operating systems.

There is no need to install any drivers with serial port support to the computer with Linux OS as the Linux system will automatically use its own generic drivers.

### 3.5 Setting of WM868-R4-LP-H module parameters by configuration cable

In following part of the document there is a description of these parameters of the WM868-R4-LP-H module, that can be displayed and examined from PC connected to the module by configuration cable. Some of the parameters can be changed by configuration commands entered „from the console” as described in paragraph 3.1.

#### 3.5.1 List of WM868-R4-LP-H module configuration parameters and commands

List of all configuration parameters of the module can be displayed by entering of ”/” (slash) command and pressing of „ENTER” key. The following list of parameters will display in the terminal window:

```
CONFIGURATION: OK
Address: 0xFFFEFB6D
Master: 0xFFFFFA63
Alarm: 0xFFFFFA63
Group: 0
Flags: C
PA table: 8A
Channel: 0
Timeslot: 20 ms
# of timeslots: 10
Hop Count: 3
Test timeout: 30 ms
Baud: 9600 8N1
Interbyte timeout: 5 ms
TX On timeout: 200 usec.
TX Off timeout: 500 usec.
Run test: 0
DEBUG: 0
sysmon>
```

List of all configuration commands (”HELP”) can be displayed by entering of ”/?” command into the command line and pressing of „ENTER” key. The following list of commands will display in the terminal window:

```
sysmon>/?
/W - save configuration
/# - clear configuration
/m addr - set Master's address
/ma addr - set Alarm address
/g group - set group (multicast address)
/h count - set hop count
/f [+][emCwzG] - set flags (e-range extender, m-master, C-Carrier Detect
                    w-WOR mode, z-Zone Extender Algorithm, G- high gain)
/c number - set RF channel 0..2
/l slots - set # of timeslots in RF network
/t timeout - set timeslot timeout in ms
/P patable - set PA table value
/T timeout - set test timeout in ms
/E flag - run test (0-Off,1-On)
/D flag - debug (0-Off,1-On)
/b baud      set baud rate (300..115200)
/p [n|e|o]   set parity (none,even,odd)
/d number    set data bits (7,8)
/s number    set stop bits (1,2)
/i timeout   set interbyte timeout in ms
/O timeout   set TX On timeout in usec.
/F timeout   set TX Off timeout in usec.
/x - RESET
sysmon>
```

Overview of configuration parameters with short description of their meaning can be also found in table 2 on the page 22.

The detailed description of individual parameters and their setting possibilities can be found in the following part of chapter 3.5.

### 3.5.2 „Configuration” group of commands for writing of configuration and reset

The module contains two sets of configuration: operating configuration and saved configuration. At the start of the system the module copies saved configuration into the operating configuration, with which continues to work. If the user changes configuration parameters, it does so only in operating configuration.

Current status of storing of configuration parameters can be displayed in the list of all configuration parameters as „CONFIGURATION” item:

```
CONFIGURATION: OK
```

Information „OK” means, that the operating configuration is stored (it is identical with stored configuration)

Information „NOT WRITTEN” means, that the operating configuration is different from the configuration stored in Flash.

Configuration can be saved to Flash memory by using of `"/W"` command. Example:

```
sysmon>/W
```

*If the current operating configuration was not stored to FLASH memory, the module returns to the saved configuration after reset. If the parameter should be changed only temporarily (for example switch-on „test” function during diagnostics), it is not necessary to save operating configuration into FLASH memory (after diagnostics the function will be switched-off anyway). If the parameter should be changed permanently, there is necessary to save the configuration to FLASH memory.*

Configuration can be **erased from the Flash memory** by using of `"/#"` command. Example:

```
sysmon>#
```

**WARNING!** This command is recommended to use only by users with good knowledge of the system, or after consultation with the manufacturer.

The **module reset** can be performed by using of `"/x"` command. Example:

```
sysmon>/x
```

After entering the command the module goes to software restart.

*Change of some configuration parameters has an effect only after module reset (e.g. retuning of module radio by changing of „SLRF Channel” parameter). In this case it is recommended to create a configuration sequence containing commands for change of parameter, saving the change to Flash, as well as command for performing of module reset (..and exactly in this order).*

### 3.5.3 Commands for settings of radio-frequency subsystem

This group of commands enables setting of transmitting, receiving, repeating and addressing system. There are following commands:

---

<code>/c number</code>	<i>frequency channel setting (SLRF Channel)</i>
<code>/h count</code>	<i>maximum number of re-transmissions (SLRF Hop Count)</i>
<code>/f[+-] flags</code>	<i>repeating mode setting (SLRF Repeater flag)</i>
<code>/F[+-] flags</code>	<i>transceiver mode setting (RF Driver flags)</i>
<code>/X time</code>	<i>receiving time interval (not used)</i>

---

Names of parameters that are configured by individual commands are stated in the brackets.

The „**SLRF Channel**” parameter is a number of module frequency channel. RF modules of WACO communication system can be tuned to any of three separate frequency channels that don't influence each other.

Frequency channel of the module can be set by `"/c [number]"` command, where value 0, 1, or 2 means number of frequency channel to be tuned. Change of frequency channel is effective only after module reset. Example of sequence of commands for module setting to the frequency channel "1":

```
sysmon>/c 1
sysmon>/W
sysmon>/x
```

The **„SLRF Hop Count”** parameter is a maximum number of re-transmissions of the messages, broadcasted by the module. If, as an example, the parameter is set to value "3", each message originated by the module will be discarded after three re-transmissions (it is repeated no more than 3 times). This mechanism prevents the system from uncontrolled circulation of the message within the network. It is recommended to set the parameter to "n" or n+1" value, where "n" is the least number of re-transmissions which is necessary to get the message to its destination. If the „SLRF Hop Count" value is too low, the message is discarded before reaching of its destination. If the „SLRF Hop Count" value is too high, capacity of the network is loaded by useless repeating of the messages.

The „SLRF Hop Count" parameter can be set by `"/h [number]"` command, where the value from 0 - 15 interval means the maximum number of re-transmissions ("hops") of the messages, broadcasted by the module. Example of command for setting of „SLRF Hop Count" parameter to value of 3 "hops":

```
sysmon>/h 3
```

The **„SLRF Repeater flags”** parameter is intended for setting of repeating (re-transmission) mode. Repeating mode can be set by using of `"/f[+-] [flags]"` command, where the required mode is chosen by entering of one of following pre-defined symbols („flags”):

- value " " (without flag) - none of below mentioned functions is involved
- value "e" - setting of basic repeating mode (without back transfer suppression)
- hodnota "Z" - setting of advanced repeating mode with back transfer suppression (AZRA)
- value "m" - designating of the module as a „Master" of virtual bus

Example of command for setting of the module as a repeater with „Advanced repeating mode AZRA" (recommended setting):

```
sysmon>/f e Z
```

The **„RF Driver flags”** parameter is intended for setting of module transceiver mode. The mode can be set by using of `"/F[+-] [flags]"` command, where the required transceiver mode is chosen by entering of one or more of following pre-defined symbols („flags”):

- value "C" - full anti-collision protection (carrier and frame transmission detect) enabled
- value "R" - limited anti-collision protection (carrier detect) enabled
- hodnota "W" - „Wake On Radio" (WOR) function of the receiver enabled
- hodnota "G" - „High Gain" function enabled (it has no effect for WM868-R4-LP-H module)

#### Important notice:

The "C" and "R" functions are alternative options and their setting works as a **change-over switch** (when one of them is enabled, second one is automatically switched off). The "W" and "G" functions are independent. Their flags can be added or removed **individually** by using of +/- symbol before the flag.

Example of command for common setting of „Full anti-collision protection" and „Wake On Radio" functions and corresponding record in the module configuration summary:

```
RF Driver flags: R
sysmon>/F C +W
RF Driver flags: CW
```

Example of command for switching of protection to „Limited anti-collision protection" mode and corresponding record in the module configuration summary:

```
RF Driver flags: CW
sysmon>/F R
RF Driver flags: RW
```

As seen in the example, by enabling of "R" function the original "C" function was automatically switched off and it had no influence on the "W" function.

Example of disabling of "W" function and corresponding record in the module configuration summary:

```
RF Driver flags:  RW
sysmon>/F -W
RF Driver flags:  R
```

As seen in the example, disabling of "W" function had no influence on the "R" function.

Example of command for common setting of "W" and "G" functions and corresponding record in the module configuration summary:

```
RF Driver flags:  R
sysmon>/F +W +G
RF Driver flags:  RWG
```

Example of command for switching of anti-collision protection to "C" mode together with disabling of "G" function and corresponding record in the module configuration summary:

```
RF Driver flags:  RWG
sysmon>/F C -G
RF Driver flags:  CW
```

*When the „Full anti-collision protection” function is switched on, the module opens its receiver for an instant before broadcasting and „listens” whether the frequency channel is clear. If a carrier frequency is detected or transmission of a frame is underway, the module postpones broadcasting of the message for a moment and then tries again. This procedure protects transmission of the message from interference with disturbing signal on the same frequency as well as from collision with broadcasting of other modules.*

*When the „Limited anti-collision protection” function is switched on, the module goes to transmission if there is no other frame underway (but, unlike the full protection, detection of carrier is not performed). This procedure does not protect broadcasting against disturbing signal, but protects transmission of the message from collision with broadcasting of other modules. This setting is recommended in this case when the module works in the environment with permanent disturbance of carrier frequency and it has no sense to waste time (and battery power) by waiting for clear channel.*

*When the „Wake On Radio” (WOR) function is enabled, the module can be anytime remotely activated from hibernated state. As the WM868-R4-LP-H module is permanently active, this function has no importance and should be switched off.*

*The „/X” command is intended for setting of „receiving time interval”, what is the interval immediately after sending a message in which the module’s receiver is active. The interval is set in „system units” of 50 ms (20 units = 1 second). As the WM868-R4-LP-H module’s receiver is permanently active, this function has no importance.*

**Important note!** Even the possibilities of transceiver settings are identical for all modifications of the WM868-R4-LP-H module, older versions of the module can have a **different way of choosing of the required transceiver mode**. In this manner the switching of transceiver mode should be performed by using of `"/f[+-]` command (the same as for setting of repeating mode), where the set of flags is supplemented with following flags for setting of transceiver mode:

- flag **"C"** for full anti-collision protection setting (Carrier Detect)
- flag **"w"** for enabling of „Wake On Radio” (WOR) function
- flag **"G"** for switching of „High Gain” function (not used)

Switching to limited anti-collision protection mode can be performed by removal of "C" flag from the configuration.

Switching from factory preset full anti-collision protection mode to the limited anti-collision protection mode can be performed this way:

```
SLRF flags:  eCz
sysmon>//f -C
... SLRF flags:  ez
```

Manner of transceiver settings control of the particular device is obvious from the summary of configuration commands („HELP”), that can be displayed by `"/?` command.

### 3.5.4 Commands for setting of addressing in virtual bus

The „Virtual BUS” application of the WACO communication system (port ”32”) enables organizing of modules of WACO WM868 series into the wireless „virtual bus”, where the communication is going on in the „master-slave” mode. All the modules in the virtual bus must have preset the same group address („SLRF Group Address”). One of the modules, that is designated as „Master” of the bus, broadcasts messages of „query” type to all other modules with using of group address of the bus, and all modules (apart from the master) send back their messages of „answer” type to the master’s individual address. The principle of addressing in the „Virtual BUS” application is depicted in the figure 16.

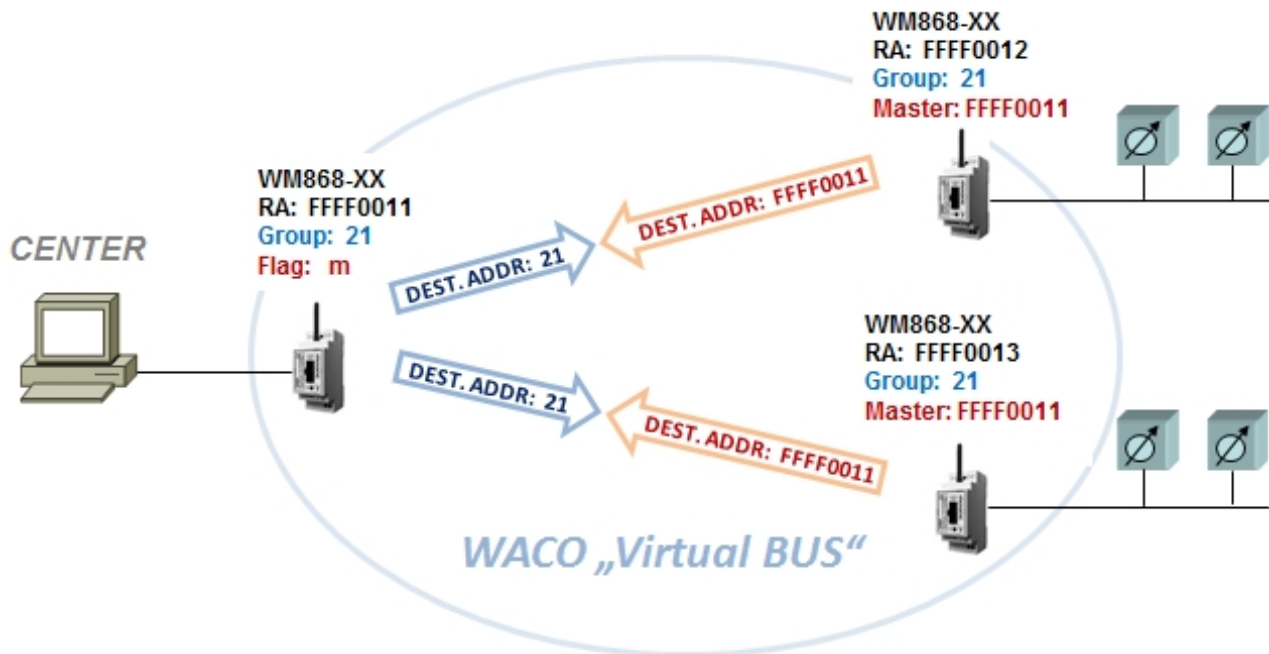

Figure 16: Principle of addressing in the WACO „Virtual BUS” application

Addressing of virtual bus can be configured with using of following commands:

<code>/f[+-] [m]</code>	<i>designating of virtual bus „master’ - see paragraph 3.5.3</i>
<code>/g group</code>	<i>setting of the module group address (SLRF Group Address)</i>
<code>/m addr</code>	<i>setting of superordinate master address (Master’s address)</i>
<code>/ma addr</code>	<i>setting of alarm messages address (Alarm address)</i>

The module can be **designated as a „master” of virtual bus** by using of `”/f”` command with `”m”` flag as described in the previous paragraph 3.5.3 ”Commands for settings of radio-frequency subsystem”.

Setting of **module group address** („SLRF Group Address”) can be performed by using of `”/g [number]”` command, where the number from 0 - 65535 interval is the module group address. Example of setting of the group address to the `”21”` value and corresponding record in the module configuration summary:

```
sysmon>/g 21
...
group: 21
```

Setting of **superordinate master address** (Master’s address) can be performed by using of `”/m [RF_address]”` command, where `”RF_address”` is the RF address of the superordinate device in hexadecimal format. Example of setting of „Master’s address” to the `”FFFE52B4”` value and corresponding record in the module configuration summary:

```
sysmon>/m 0xfffe52b4
...
Master: 0xFFFE52B4
```

By using of `”/ma”` command there is possible to preset similarly RF address of the network element (module), that is responsible for collecting of **alarm type** messages. The module will send all alarm messages to the preset



Alarm address (independently on the "Virtual BUS" setting). As there is no alarm application supported in current version of the module, it is recommended not to use this command.

The WM868-R4-LP-H module with RS-485 interface can be used on the main WACO virtual bus segment (together with bus control unit - „Master”), or on the remote segment of virtual bus (together with connected „slave” device). Therefore the module configuration should be different: either as a „master” of virtual bus (with [m] flag in setting of "/f" parameter), or on contrary, in position of remote bus-segment communicator (with master's RF-address set by "/m" command).

### 3.5.5 Commands for setting of RS-485 interface

This group of commands is intended for setting of RS-485 data-bus interface parameters that is used for communication with connected meters/sensors. There are following commands:

---

<b>/b baud</b>	<i>setting of data-bus bit speed (300 - 115200)</i>
<b>/p [n/e/o]</b>	<i>setting of data transfer parity (none,even,odd)</i>
<b>/s number</b>	<i>setting of stop-bit number (1 or 2)</i>
<b>/d number</b>	<i>setting of data-bit number (7 or 8)</i>
<b>/i timeout</b>	<i>setting of interbyte timeout in ms</i>
<b>/O timeout</b>	<i>setting of link transmission delay ("TX On timeout") in <math>\mu</math>sec.</i>
<b>/F timeout</b>	<i>setting of link amplifier delay ("TX Off timeout") in <math>\mu</math>sec.</i>

---

The **"/b [baud]"** command can be used for setting of **bit transfer speed** („communication speed”) on the serial/bus interface. The speed must be adjusted to the value, that is suitable for connected meters. Setting will be effective only after module restart. Example of setting of the communication speed to "9600" baud value:

```
sysmon>/b 9600
```

The **"/p"** command can be used for setting of **parity bit** of the serial/bus interface. There are five options of parity bit setting:

- value **„n"** means „none parity” (none)
- value **„e"** means „even parity” (even)
- value **„o"** means „odd parity” (odd)

Example of setting of the parity bit to "even":

```
sysmon>/p e
```

The **"/d"** command can be used for setting of **number of data bits** of the serial/bus interface, where the number "7" or "8" can be used. Example of setting of the number of data bits to "8" value:

```
sysmon>/d 8
```

The **"/s"** command can be used for setting of **number of stop-bits** of the serial/bus interface, where "1" or "2" value can be used. Example of setting of the number of stop-bits to "1" value:

```
sysmon>/s 1
```

The **"/i"** command can be used for setting of **interbyte timeout** of the serial/bus interface. Interbyte timeout is set in milliseconds. Example of setting of interbyte timeout to "10 milliseconds" value:

```
sysmon>/i 10
```

*The module gradually (one-by-one) stores incoming Bytes from serial interface into radio-packets and (when the packet is loaded) sends the packets through RF interface to other module. If there is a „silence” after last received Byte longer than interbyte timeout, data sequence is considered as complete (no more data are expected) and radio-packed is transmitted, even if it is not fully loaded.*

Setting of all serial/bus interface parameters is stated in the list of all configuration parameters in following rows:

```
Baud: 9600 8E1  
Interbyte timeout: 10 ms
```

The **/O timeout** and **/F timeout** commands can be used for setting of delays in switching of RS-485 link amplifier on/off. These timeouts help with elimination of transitional process effects during switching of link amplifier between transmitting and receiving mode. It works in the following way:

- when the module is in receiving mode and there are data ready for transmission, link amplifier is switched to TRANSMIT mode and waits some time before the data are really transmitted. This delay is designated as „TX On timeout”;
- when the module has transmitted last byte of data into the bus, link amplifier is held some additional time period in TRANSMIT mode. If some new data for transmission appear during this period, the module transmits the data immediately. If no other data are ready for transmission, link amplifier goes to the RECEIVE mode on expiration of the period. This delay is designated as „TX Off timeout”.

The **/O timeout** and **/F timeout** periods can be preset by following commands:

```
sysmon>/O 100
sysmon>/F 3000
```

Current setting of both timeouts is also shown in the configuration status and it is not recommended to change it groundlessly.

### 3.5.6 Setting of test broadcasting

These commands can be used for setting of **test broadcasting function** of the module, that can be used for evaluation of radio signal in the installation site. When this function is switched on, the module broadcasts test messages in regular intervals and a quality of their reception can be evaluated around the module with using of WACO RF analyzer or any similar device.

The **"/T"** command can be used for setting of **period of the test broadcasting**. Length of the period is entered in „system units”, where the value of one system unit is 50 ms (value of „100 units” means 5 second period). Example of setting of the testing period to 10 second (200 system units):

```
sysmon>/T 200
```

By using of the **"/E [0/1]"** command the function of **test broadcasting can be switched "on" and "off"**. Test broadcasting is switched on with using of **"/E 1"** command, and it is disabled by using of **"/E 0"** command. Example of test broadcasting switching "on" command:

```
sysmon>/E 1
```

**WARNING!** Do not set "T" parameter to less than "50" value, otherwise the module buffers could be overloaded.

### 3.5.7 Special commands for module activation and diagnostics

This group of commands is intended for the module initial setting during the manufacturing process, and for module diagnostics by manufacturer. It is strongly recommended using of these commands only by users with a very good knowledge of the system, or only after consulting with manufacturer. There are following commands:

---

<b>/P number</b>	<i>transmitting power setting (Do not use! Only for factory setting!)</i>
<b>/l slots</b>	<i>number of transmitting timeslots (Do not use! Only for factory setting!)</i>
<b>/t timeout</b>	<i>length of transmitting timeslot (Do not use! Only for factory setting!)</i>
<b>/D number</b>	<i>„debug" statement switch-on (Do not use! Only for factory setting!)</i>

---

### 3.5.8 Module current status statement

The **module current status statement** can be displayed by entering of **"i"** command (without „slash") into the command line and pressing of „ENTER" key. Following statement will appear in the terminal window:

```
sysmon>i
DATE: 6:3:44 1.1.1970
uptime=21824 systime=21824
RF state=3 A rfaTimeoutCnt=0, timeout=0 tempTimeout=0
sysmon>
```

In the first row of the statement there is a value of module **system time** in common data format. In the second row there are values of **uptime** and **sysptime** in Unix data format. In the third row there are statuses and statements of some program sections (they could vary for different module modifications), that can be used only for module diagnostics.

The **„Sysptime”** parameter value shows setting of module real time. System time is kept in the same format as in computer operating systems, i.e. in seconds, starting from 1.1.1970 („UNIX Epoch time”). In default status (after battery switch-on) there is zero value in the counter and it increases by one every second. The module can be synchronized with the real time only via radio, by using of the **SET** command of the WACO RFAN analyzer (see paragraph 3.6). Setting of this parameter is not required for any common application of the module.

The **„Uptime”** parameter value shows the time interval passed from the last device reset in seconds so that the exact moment of the last module reset can be recognized by this parameter. The parameter is of „read only” type.

### 3.6 Setting of WM868-R4-LP-H module parameters via radio

Almost all parameters described in paragraph 3.5 „Setting of WM868-R4-LP-H module parameters by configuration cable” can be set alternatively via radio, with using of ”WACO Radio-Frequency Analyzer RFAN 3.x”. General description of configuration via radio can be found in section 3.2 „Configuration of the module via radio”, where there are explained relevant general rules as well as working procedure in steps.

The only parameter of the WM868-R4-LP-H module, that can be set **only via radio**, is module **System Time**. However, this setting is not required for any common application of the module.

The module can be synchronized with real time by using of ”SET” command. Open the ”Add variable” form, select ”Systime (s)” variable in ”OID” field, and set current time in ”UNIX time” format into the ”Value” field as described in figure 17.

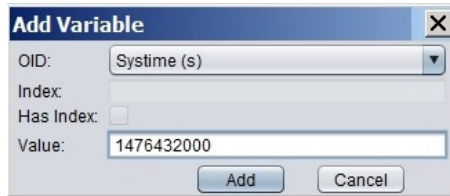

Figure 17: Setting of module System time via radio

List of all variables of the WM868-R4-LP-H module that are accessible via radio, as displayed by the RFAN 3.x analyzer after using of „WALK” command, is shown in the figure 18.

Index	OID	index	OID Name	Value	Done
1	1		Device name	WM868-R4-LP-H	<input type="checkbox"/>
2	2		Device type	868	<input type="checkbox"/>
3	3		Device subtype	48	<input type="checkbox"/>
4	4		Manufacturer #	0xff 0xfe 0xfb 0x6d	<input type="checkbox"/>
5	5		HW Version	1	<input type="checkbox"/>
6	6		HW Revision	33	<input type="checkbox"/>
7	7		SW Version	5	<input type="checkbox"/>
8	8		SW Revision	0	<input type="checkbox"/>
9	12		Uptime (s)	21941	<input type="checkbox"/>
10	13		Systime (s)	2133153140	<input type="checkbox"/>
11	14		Reset code	0	<input type="checkbox"/>
12	15		Configuration status	2	<input type="checkbox"/>
13	61		Sequence #	0	<input type="checkbox"/>
14	100	1	Input value	1	<input type="checkbox"/>
15	100	2	Input value	1	<input type="checkbox"/>
16	100	3	Input value	1	<input type="checkbox"/>
17	100	4	Input value	1	<input type="checkbox"/>
18	110	1	SLRF Channel	0	<input type="checkbox"/>
19	111	1	SLRF Hop Count	3	<input type="checkbox"/>
20	112	1	SLRF # of timeslots	10	<input type="checkbox"/>
21	113	1	SLRF Timeslot [ms]	20	<input type="checkbox"/>
22	114	1	SLRF Group Address	0	<input type="checkbox"/>
23	115	1	SLRF Master Address	0xff 0xff 0xfa 0x63	<input type="checkbox"/>
24	116	1	SLRF Repeater flag	0	<input type="checkbox"/>
25	117	1	SLRF Master flag	0	<input type="checkbox"/>
26	118	1	SLRF My Address	0xff 0xfe 0xfb 0x6d	<input type="checkbox"/>
27	120	1	SLRF last RSSI	-46	<input type="checkbox"/>
28	122	1	SLRF CD flag	1	<input type="checkbox"/>
29	123	1	SLRF Test flag	0	<input type="checkbox"/>
30	124	1	SLRF Test timeout [ms]	30	<input type="checkbox"/>
31	125	1	SLRF TX power	138	<input type="checkbox"/>
32	126	1	SLRF Alarm Master	0xff 0xff 0xfa 0x63	<input type="checkbox"/>
33	130	1	Interface name	ser1	<input type="checkbox"/>
34	131	1	Interface Admin status	1	<input type="checkbox"/>
35	132	1	Interface Oper status	1	<input type="checkbox"/>
36	133	1	Interface speed	57000	<input type="checkbox"/>
37	134	1	Interface parameters	8n1	<input type="checkbox"/>
38	135	1	Interface TX On timeout [ms]	200	<input type="checkbox"/>
39	136	1	Interface TX Off timeout [ms]	500	<input type="checkbox"/>
40	137	1	Interface interbyte timeout [m	5	<input type="checkbox"/>

Figure 18: Table of all WM868-R4-LP-H module variables displayed by RFAN 3.x analyzer

### 3.6.1 Overview of module configuration parameters

Overview of configuration parameters that can be used for user settings of the WM868-R4-LP-H module is shown in the Table 2 below. The parameters are presented in the same order as they appear in the List of configuration parameters (see paragraph 3.5.1).

In the „**Value**” column there is a recommended range of setting of the particular parameter. If there is a „Code” indication in this column, it means that the value is shown in form of hexadecimal code, where couple of hexadecimal characters represents one Byte.

In the „**Default**” column there are default (factory) settings of the parameter. Colour marking of this field has following meaning:

- green colour - commonly used parameters that should be set in reliance on the specific usage
- red colour - parameters that are not recommended to change
- grey colour - values that cannot be changed („read only”)

Table 2: Overview of WM868-R4-LP-H module configuration parameters

Item	Name	Value	Description	Default.
1	CONFIGURATION	status	configuration saving status	read only
2	Address	code	module unique WACO RF-address	read only
3	Master	code	virtual bus master’s RF-address	
4	Alarm	code	RF-address for sending alarms	
5	Group	0 - 65535	module group (multicast) RF-address	0
6	Flags	e,z,C,w,G,m	switching of transceiver/repeater mode	
7	PA table	code	setting of transmitting power	80
8	Channel	0 - 2	frequency channel number	0
9	Timeslot		length of repeating time-shift timeslot	1 ms
10	No of timeslots		maximum of repeating time-shift timeslots	5
11	Hop Count	0 - 15	maximum number of message repeating	3
12	Test Timeout	20	period of test broadcasting	1
13	Baud	300 - 115200	data-bus transmission speed	2400
14	Data bits	7, 8	data-bus setting (data bits)	8
15	Parity	code	data-bus setting (parity)	E
16	Stop bits	1, 2	data-bus setting (stop bits)	1
17	Interbyte Timeout	1000	data-bus setting (Interbyte timeout)	10
18	TX On	timeout	Link transmission delay ”TX On timeout”	200 $\mu$ sec
19	TX Off	timeout	Link amplifier delay ”TX Off timeout”	500 $\mu$ sec
20	Run test	0 / 1	switching of test broadcasting	0
21	Debug Level	code	switching of debug logging level	

### 3.7 Structure of module data messages

The module communicates with other elements of the WACO RF network by data messages of the WACO SLRF communication protocol, which observes ISO/OSI communication model, its typical features are high effectivity and reliability, and enables huge variability of supported applications. A structure of individual layers of the WACO SLRF protocol is shown in the figure 19.

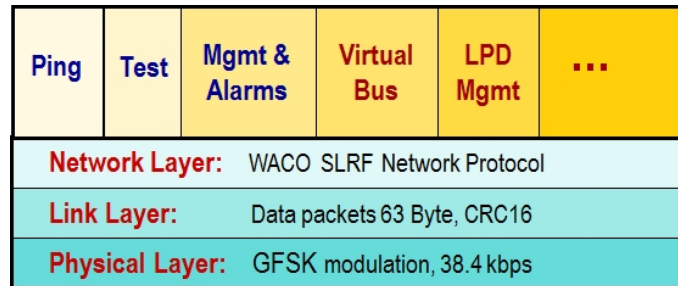

Figure 19: WACO SLRF protocol structure

Maximum total length of WACO SLRF data packet („packet”) is 63 Byte. The packets are bordered by preamble code and synchro-bits (6 Byte in total) at the beginning and by 16-bit checksum code (CRC) at the end.

Each data message contains 11 Byte long fixed header and data content („Payload”) with maximum length of 52 Byte. Packet header is very simple and contains only information that are necessary for routing of the packet (source and destination address, hop count, transaction ID) and a type of respective application („port number”). Payload data coding method is determined by application type. WACO SLRF data packet structure is shown in the figure 20.

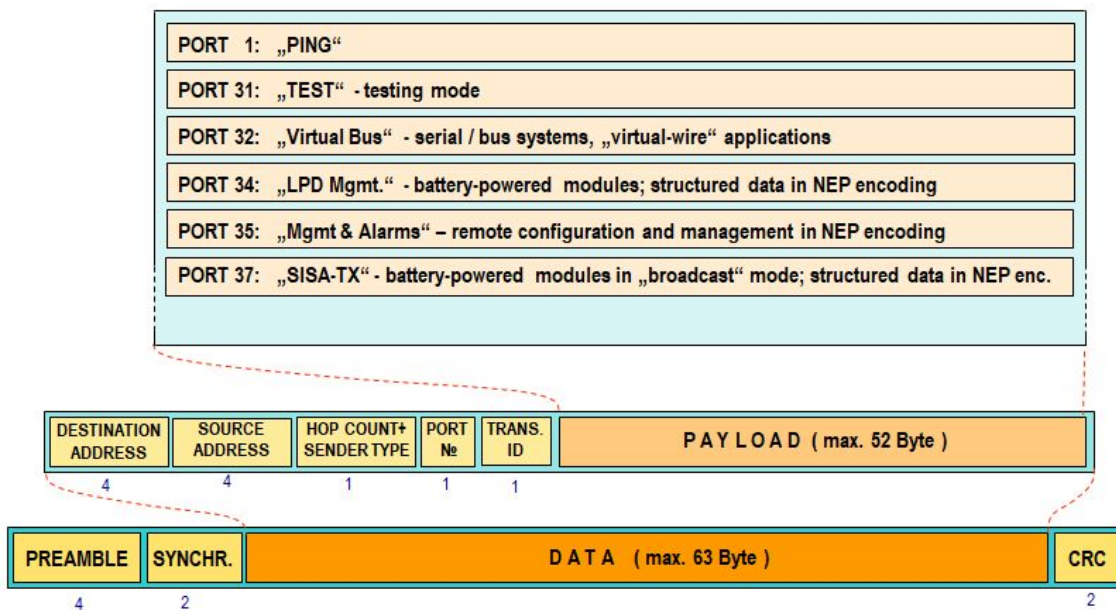

Figure 20: Structure of WACO system data packet

The WM868-R4-LP-H module is intended for transparent data transfer among remote segments of virtual data bus (RS-232, RS-485, M-Bus...) through the WACO RF-network. The data transfer is going on in the „Virtual BUS” application (port „32”), where the data messages are transferred through the RF-network totally transparently.

The module receives messages from the RS-485 serial line and inserts their content (whole and unchanged) to the payload of WACO SLRF radio-messages. If the original message is longer than maximum radio-packet data payload (52 Byte), it is divided (fragmented) to several parts and transmitted gradually, one-by-one, in several packets (for more details see description of „Interbyte timeout” parameter in paragraph 3.5.5).

In reverse direction it works analogously - the data content from received RF packets is transmitted transparently (without any change) to the RS-485 serial line.



## 4 Operational conditions

This section of the document describes basic recommendations for transportation, storing, installation and operation of WM868-R4-LP-H radio modules.

### 4.1 General operational risks

The WM868-R4-LP-H radio-modules are electronic devices powered from an external power source that can be used for transparent data transfer among remote segments of WACO virtual network. During the operation of the modules there are following potential risks:

#### 4.1.1 Risk of mechanical damage

The devices are covered in plastic boxes, so electronic components are not accessible for a direct mechanical damage. When installing it is necessary to ensure a sufficient space for connecting cables (including the configuration cable) and also that the cables are as short as possible (especially power and antenna cables). It is necessary to ensure the proper fastening of the module to DIN-rail with a plastic lock. In normal operation no special precautions are needed, besides avoiding of the mechanical damage from strong pressure or shocks.

Special attention is required for power, communication/signaling and antenna cables. In operation it is necessary to ensure that the cables are not stressed by mechanical tension or bending. In the case of damage of any cable isolation it is recommended to replace the cable immediately. If the module is equipped with a remote antenna on a coaxial cable, much attention should be paid for the antenna and the antenna cable as well. The minimum bending radius of the antenna cable with 6 mm diameter is 4 cm, for the antenna cable with the 2,5 mm diameter the bending radius is 2 cm. Violation of these bending parameters can lead to breach of homogeneity of the coaxial cable that could cause reducing of radio range of the device. Further it is necessary to ensure that the connected antenna cable will not stress the antenna connector of the device by tension or twist. Excessive loads can damage or destroy antenna connectors.

The module is specified for installation in normal internal premises with the temperature range of  $(-10 \div +50)^{\circ}\text{C}$ , with humidity up to 90% without condensation. Direct installation of the equipment in outdoor areas is not possible.

#### 4.1.2 Risk of electrical damage

Electrical installation of the module can be performed only by a person with necessary qualification in electrical engineering and at the same time trained for this device installation. The device is powered by DC power with safe voltage up to 24 V and current consumption up to 200 mA.

The power supply must meet the requirements for the safety protective transformer ČSN-EN61558-2-6. The module has an integrated protection against reversing the polarity of the supply voltage. Reversing the polarity is indicated so that after switching on the supply voltage to the module a green LED „PWR” on the front panel does not shine. Unwanted reversing the polarity of the supply voltage does not lead to damage or destruction of the device. In addition, the module is on the supply inlet equipped with an irreversible fuse (polyswitch) with the actuating current of 300 mA and over-voltage protection with 30 V switching level.

The module is not equipped by any disconnecting component – switch. It is suitable to place in installation a disconnecting component, for example a circuit breaker, which can be inserted into 24V/DC lateral of the supply or into the 230V/AC side of the supply. The primary side of the power source must be protected by automatically irreversible fuse.

### 4.2 The condition of modules on delivery

Modules are delivered in standard cardboard boxes. At standard term of delivery the module does not include the antenna, the power supply and cables, if required these components must be ordered separately.

### 4.3 Modules storage

Modules should be stored in dry rooms with a temperature range  $(0 \div 30)^{\circ}\text{C}$ .

## 4.4 Safety precautions

**Warning!** Mechanical and electrical installation of the WM868-R4-LP-H module can be provided only by a person with necessary qualification in electrical engineering.

## 4.5 Environmental protection and recycling

The equipment does not contain exchangeable components, which require compliance with specific rules in terms of environmental protection for their replacing, storage and disposal. Damaged, destroyed or discarded devices cannot be disposed as household waste. Equipment must be disposed of in the waste collection yards, which dispose electronic waste. Information about the nearest collection yard can be provided by the relevant local (municipal) authority.

## 4.6 WM868-R4-LP-H module installation

The WM868-R4-LP-H radio modules are enclosed in plastic casings with an IP20 degree of protection equipped by plastic locks for mounting on the DIN-rail. Casings should not be open under mounting, dismantling and normal operation.

Detailed view of the WM868-R4-LP-H module from the power supply clamps side and from the rear side is shown in figure 21.

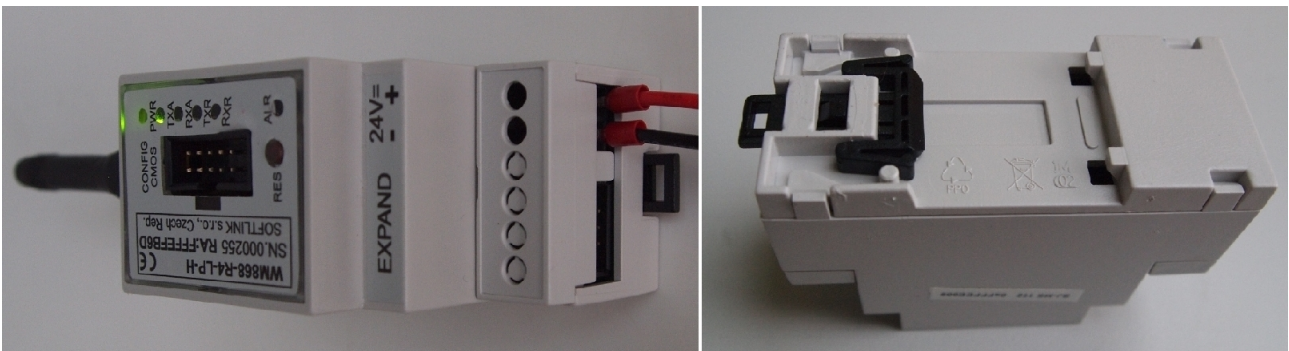

Figure 21: Detailed view of WM868-R4-LP-H module

Installation of the module should be performed by the following procedure:

- installation of the module can be performed only by a person with necessary qualification in electrical engineering and at the same time trained for this device installation;
- when selecting an installation site pay attention to secure sufficient space for connection of antenna, power and signaling cables to the module (see paragraph 4.1.1 „Risk of mechanical damage”). It is necessary to keep the sufficient space for the connecting of configuration cable as well;
- when selecting a site for the module installation it is necessary to choose a place with availability of power supply. The power supply should be placed close to the module so that the feed of 24 voltage is as short as possible. Further it is necessary to consider the method of the module switching off and location of an appropriate disconnecting element (see paragraph 4.1.2 „Risk of electrical damage”).
- mount the module to the selected place on the DIN-rail. Pull down black plastic lock in the bottom side of the module (outward of the module), attach the module to the DIN-rail so that the rail fits into the slot on the rear side of the module and push the black plastic lock up (inward the module);
- connect the antenna and signal cables to the module;
- make sure that the power supply is turned off and connect the power cable to the module. Verify that the polarity of power supply corresponds with the marking on the module terminals;
- check whether everything is properly connected and fastened and turn on the power supply. Green LED „Power” will shine on the module and the operation system will start up;
- perform the basic diagnostic of the module in compliance with the procedure mentioned in the paragraph 4.9 „Functional check of the module” and possibly (if the module was not pre-configured during the preparatory stage of installation) its configuration with using of the configuration cable according to the procedure described in the paragraph 3 „Configuration of the module individual parameters”;

- record information about the module installation (serial number, position, picture of installation...) to the operational documentation under internal rules.

When locating installation site, selecting antenna type and antenna position it is necessary to take into account conditions for radio signal propagation in the area of installation. The conditions is possible either estimate empirically on the base of previous experience, or accomplish a measurement of the signal strength by the signal analyzer.

## 4.7 Module replacement

When there is necessary to replace the module due to the module failure follow this procedure:

- switch off the power supply and disconnect the power cable wires from the module;
- disconnect the signal cable and the antenna cable;
- release the module from DIN-rail by pulling down of the black plastic lock on the bottom side of the module down (outward of the module) and remove the module from the rail;
- attach the new module at the place of the original module and proceed further according to the procedure mentioned in the paragraph 4.6. Especially pay attention to the correct connection of the power cable;
- after switching power on perform the diagnostics and set-up parameters;
- label the original module as „defective” and fill in the appropriate documentation prescribed by internal rules for this case.

## 4.8 The module dismantling

When dismantling module turn the power supply off and disconnect the power supply cables from the module. Disconnect the signal cable and the antenna cable from the module. Release the module from DIN-rail by pulling down of the black plastic lock on the bottom side of the module (outward of the module). If there is no further use for the antenna, remove the antenna cable and the antenna. If there is no further use for the power supply, remove the power supply and the power cable. If the power supply is used for other purposes, secure power cables against short circuit (by insulation of live ends of wires or by removal of useless power branches) and connect the power supply again. After dismantling label the module properly as „dismounted” and fill in the appropriate documentation prescribed by internal rules for this case.

## 4.9 Functional check of the module

After putting the module into operation (or after each repair and replacing of the module) it is recommended to check module basic functionality as follows:

- check broadcasting functionality by RFAN 3.x analyzer in ”Packets” or ”Radar” mode (according to the analyzer documentation) with using of „test broadcasting” function described in the paragraph 3.5.6 „Setting of test broadcasting”;
- check receiving of data from all other WACO RF modules of the virtual bus, that communicate through the module. This check can be performed indirectly, by inspection of table of readings collected by bus control unit („Master”), or by inspection of gathered data in the remote reading application. If all readings are available and up-to date, the module is apparently functional;
- when in doubt, the presence and quality of RF signal from particular module can be tested by RFAN 3.x analyzer in ”Packets” or ”Radar” mode (according to the analyzer documentation);
- perform overall check of transmitter and receiver functioning by testing of remote configuration via radio with using of RFAN 3.x analyzer (i.e. reading of any module’s parameter by ”GET” command as described in chapter 3.2 „Configuration of the module via radio”);
- complex end-to-end check of the WM868-R4-LP-H module functionality (including correctness of setting of the central database) can be performed by trial reading of data from all remote segments of the virtual bus and inspection of gathered data.

## 4.10 Operation of the WM868-R4-LP-H module

The WM868-R4-LP-H module performs broadcasting and receiving of radio messages and communication through the RS-485 bus fully automatically. When the RF-network is overloaded by heavy radio traffic, temporary loss of messages or short-time breakdowns of connection with some modules can occur due to signal collisions.

The greatest risks of permanent breakdown of module RF communication (or communication breakdown of local wired bus) are commonly caused by human activities within the installation site. It is mainly about the following risks:

- turning off the module power (e.g. circuit breaker failure or unintentional shutdown);
- temporary or permanent shading of the antenna (e.g. due to building operations);
- mechanical damage of the module, antenna cable, antenna or RS-485 signal cable by handling things at the installation site.

To eliminate these risks, it is recommended to pay close attention to selection of the installation site and choice of antenna and antenna location so that to find appropriate compromise between qualities of signal and the level of risk of mechanical damage of the module or antenna. It is necessary to carry out the installation carefully with using of high-quality cables and mounting components.

To prevent an unexpected breakdown, it is recommended to perform regular monitoring of all broadcasting data, i.e. readings, processor temperature and voltage. If some of the parameters goes beyond the common steady value, it is recommended to contact the installation site caretaker and ask for the potential cause of the anomaly or perform the physical check on the installation site.

## 5 Troubleshooting

### 5.1 Possible causes of module failures

If during operation of WM868-R4-LP-H module some anomaly, malfunctions or other troubles are recognized, the possible causes of the failures can be classified by following categories:

#### 5.1.1 Power supplying failures

The module requires an external power supplying according to the specification in paragraph 2 „Technical parameters overview”. Power supplying voltage is signaled by shining of green LED ”PWR” on the module front panel. Malfunction or breakdown of the power supplying will cause a complete breakdown of the device. Correctness of power supplying can be checked by this procedure:

- check if there is no electricity breakdown in the building;
- check, if the power supply is ”on” and properly working;
- check on the installation site whether the module is really under voltage (that means the ”PWR” LED is shining);
- in case of any doubt take the measurement of the voltage.

If the reason of the failure is external power supplying system, repair the power supply or power distribution system. In case of failure of power supply, circuit breaker, surge protection (or any other protecting element) try to find out the primary cause of the failure, especially check short circuit possibility caused by penetration of humidity or water or malfunction of other device connected to the same power supply.

If the power supplying is properly working with correct voltage but the green ”PWR” LED is still not shining, the module is probably out of order. Perform the replacement of the module according to the instructions in paragraph 4.7 and check functionality of the new module. If the new device works properly, label the original module as „defective” and fill in the appropriate documentation prescribed by internal rules for this case.

#### 5.1.2 System failures

As „system failure” are considered mainly failures of module’s processor, memory, internal supplying or any other failures that cause a complete breakdown of the device. If the power supplying of the module is properly working with correct voltage (green ”PWR” LED is shining) but the device still does not communicate through its configuration port and does not respond to any commands and this status will not change even after module’s restart (by ”RES” button on the front panel), the system failure probably occur. Perform the replacement of the module according to the instructions in paragraph 4.7 and check functionality of the new module. If the new device works properly, label the original module as „defective” and fill in the appropriate documentation prescribed by internal rules for this case.

### 5.1.3 Transmitter and receiver failures

Transmission and reception of RF messages is signaled by flashing of yellow "TXA" / "RXA" LEDs and red "ALR" LED on the module front panel. The "TXA" LED blinks when a radio message is transmitted, the "RXA" LED blinks when a radio-message is received. When transmitting of message is postponed by anti-collision system, the red "ALR" LED is flashing.

If the module is powered by correct voltage, the module communicates through the configuration port, responds to the configuration commands but the radio-messages from the module are still not received steadily, the possible reason of the trouble can be a failure of transmitting or receiving of radio signal. The typical indication of transmitting or receiving failures is state of „partial" functionality, that have following external signs:

- the module transfers data only from certain elements of the radio-network, data from other elements are not transferred;
- certain elements of the network do not receive data from the module;
- data from certain elements of the network are incorrect or incomplete;
- there are numerous breakdowns in the data communication (sometimes the data pass through the module, sometimes not).

All above described troubles could have on common ground, which is unreliability of radio-communication caused by one of these reasons:

- incorrect setting of transmitter parameters, mainly frequency channel, maximum number of re-translations, or transmitting power;
- permanent or occasional blocking of radio signal caused by construction works or any construction changes within the premises, or by operation around the installation site (moving of machines, cars, etc.);
- permanent, periodical or occasional interference (jamming) of radio signal from external source (another radio system in the same frequency band, or industrial disturbance).
- low level of transmitting signal caused by wrong setting or failure of transmitter;
- low level of receiving signal caused by wrong setting or failure of receiver;
- low level of transmitting and receiving signal caused by damage of antenna or antenna cable (if external antenna used).

If above described indications of unreliable radio-communication become evident, proceed with troubleshooting of the malfunctioning in following steps:

- visually check surrounding of the installation site to find out if there are any changes that can influence radio signal (e.g. new objects, things, machines...). If there are such negative circumstances, solve the trouble by reorganization of the object or by redesign of radio network;
- visually check an external antenna and antenna cable (if used), possibly replace these elements for the spare ones with proven functionality;
- check correctness of module settings, especially setting of radio parameters as described in paragraph 3.6 and perform the check of module overall functionality as described in paragraph 4.9;
- if there are breakdowns in communication with some specific element of the network, check functionality of that element according to the respective documentation;
- replace the module according to the paragraph 4.7 and perform the setting and check of overall functionality off the new module after that;
- if the module is not properly working even after its replacement for proven device and equipment, the trouble can be caused by local interference (jamming) from external source. Another possible reason could be an unsuitable setting of some configuration parameter that has not been discovered. In this case ask for your supplier, producer, or other experienced person for some form of assistance.

Appropriate level of transmitting power can be checked by comparing of its signal strength with the reference signal from another module (modules) under comparable circumstances, for example with using of signal analyzer or testing receiver placed to the suitable spot. If the signal strength is similar to the signal of reference transmitter, then the module's transmitting power is adequate, and the reason of troubles could be in insufficient signal strength on the receiving side. Attenuation of the signal can be caused by making of some change in module installation site (e.g. turning of antenna or placing of some object nearby, installation of iron bars, rack or shelves...) or similar changes in the installation site of receiver (GateWay). This kind of troubles can be solved by redesign of the radio network in order to secure sufficient signal reception (that means changing of antenna for better type, moving of antenna or whole device etc.).

Presence of radio-disturbance is signaled by frequent (or permanent) flashing of red "ALR" LED.

### 5.1.4 Data bus failures

Functioning of data bus is signalled by flashing of pair of yellow "TXR" and "RXR" LEDs, that signal transmitting of a message into the bus (flashing of "TXR" LED) and receiving of a message from the bus (flashing of "RXR" LED).

Data bus failures manifest themselves by full or partial malfunctioning of the bus communication. Module with inoperative data bus communicates through its configuration port, responds to configuration commands, but the messages from some of the connected meters (or from all of them) do not come to the radio network (or vice versa - messages from the radio network don't come to the devices on the bus.). In some cases the malfunction of the bus is partial - interruptions are either random in time or their affect is limited to only some of the connected devices (meters, sensors).

Data bus failures and breakdowns can be caused by following reasons:

- incorrect setting of data bus parameters as described in paragraph 3.5.5, or discrepancy between bus parameters of the module and connected device;
- mechanical damage of the bus cable;
- fault of module's link amplifier;
- worsening of the bus transmission capacity as a result of some changes or modifications of the bus (...a new device connected to bus, order alteration, wiring replacement, terminator connection/disconnection...);
- disturbance of the electrical signal within the bus by induction of the interfering signal into the bus, or troubles caused by differences of electrical potential among devices connected to the bus.

**Recommendation:** *Troubles with bus transmission capacity as described in the last two items generally occur especially if there is a bus with lengthy wiring and with high number of connected devices. Troubleshooting of the bus failures can be quite complicated and requires a specific knowledge and experiences. It is recommended to entrust the task to the specialist with experiences with given type of bus.*

If there is a suspicion that the operational troubles with data collection from the remote bus could be caused by failure of data bus itself, first of all check correctness of data collection system settings, especially correct identification (addressing) of individual devices within central system (master) database. If the correctness of the identification is positively checked, proceed with troubleshooting of the data bus communication malfunctioning in following steps:

- visually check whether the bus cable from the given meter/sensor is attached correctly to the module and test its functionality by ohmmeter. If the inspection of the cable shows any signs of its damage (or it is evidently inoperative), repair or replace the cable immediately;
- if the bus wiring is undamaged and messages from other devices on the same bus came to the central system correctly, check consistency of setting of bus parameters within the module configuration and within the connected meter/sensor as described in the paragraph 3.5.5 „Setting of parameters of the RS-485 bus”
- if the bus is physically functional and its configuration is correct and consistent with setting of connected devices, but the communication through the bus is still non-functional, the WM868-R4-LP-H module is probably defective and it is necessary to make its replacement as described in the paragraph 4.7;
- if the bus communication will not work properly even after replacement of the module, the bus is physically apparently functional, configuration of the module is correct, addressing is in harmony with setting of bus „Master”, but the messages still don't pass through the bus, the bus is probably not working correctly on the data level. In this case try to make some changes in the bus setting on the „Master” side (different speed, different Inter-Byte timeout...) that is possible to make and could have some influence on the bus communication. In this case it is recommended to ask for advice/support some person with broad experiences in bus communication or module producer.

## 5.2 Troubleshooting procedure

To identify a reason of device failure or any anomaly in its operation follow this procedure:

1. **The WM868-R4-LP-H module is installed in the main segment** of WACO virtual bus (i.e. it communicates with bus control unit through its serial interface)
  - (a) No data are available from any segment of virtual bus. In this case it is recommended to check functionality of the module subsystems in following order:
    - check functionality of power supplying as described in the paragraph 5.1.1 „Power supplying failures”
    - check functionality of the system as described in the paragraph 5.1.2 „System failures”
    - check serial line functionality as described in the paragraph 5.1.4 „Data bus failures”



- check transmitting and receiving functionalities as described in the paragraph 5.1.3 „Transmitter and receiver failures”
- (b) No data are available from only one remote segment of virtual bus. In this case it is recommended to check functionality of the module subsystems in following order:
- check functionality of remote segment data bus, its RF-communication module and connected meters/sensors
  - check correctness of central application configuration related to the meters/sensors on the remote bus segment.
  - check transmitting and receiving functionalities as described in the paragraph 5.1.3 „Transmitter and receiver failures”
2. **The WM868-R4-LP-H module is installed i the remote segment of WACO virtual bus** (i.e. it communicates with connected slave device through its serial interface)
- (a) No data are available from any the device (meter/sensor) connected to its serial interface. In this case it is recommended to check functionality of the module subsystems in following order:
- check functionality of power supplying as described in the paragraph 5.1.1 „Power supplying failures”
  - check functionality of the system as described in the paragraph 5.1.2 „System failures”
  - check serial line functionality as described in the paragraph 5.1.4 „Data bus failures”
  - check transmitting and receiving functionalities as described in the paragraph 5.1.3 „Transmitter and receiver failures”
- (b) no data are available only from one device (meter/sensor) connected to the wired bus. In this case it is recommended to check functionality of the module subsystems in following order:
- check functionality of connected meter/sensor
  - check correctness of „Master” database configuration related to the meter
  - check wired bus functionality as described in the paragraph 5.1.4 „Data bus failures””
- (c) Data from the device connected to its serial interface are coming to the central database unreliably, with random or periodical dropouts. In this case it is recommended to check functionality of the module subsystems in following order:
- check serial line functionality as described in the paragraph 5.1.4 „Data bus failures”
  - check transmitting and receiving functionalities as described in the paragraph 5.1.3 „Transmitter and receiver failures”

*Observation of blinking of yellow LEDs (that indicate data transfer through the RF-subsystem and physical bus/serial interface) can be very helpful for identification of possible trouble. After each request of WACO virtual bus „Master” and consequent answer of the „Slave” device the LEDs should be blinking almost simultaneously as the message goes through: „RXA”, „TXR”, „RXR” and „TXA”.*

**NOTE: WM868-R4-LP-H module is a reliable device with relatively simple and resilient construction, so that any possible failure of the device is very likely caused by external circumstances, especially installation environment, mechanical damage, excessive humidity, overvoltage of power supplying, or voltage pulses induced to the module data bus. After each replacement of the module caused by its failure it is recommended to check the root cause of the failure and take necessary measures to eliminate any persisting troubles.**

## 6 Additional information

This manual is focused on description, parameters and configuration options of radio modules WM868-R4-LP-H of the WACO RF system, operating in the 868 MHz band, that are a part of the Softlink's **wacoSystem** product family. More information about all WM868 (WACO), WB169 and WB868 (Wireless M-BUS), or WS868 (Sigfox) series of the modules can be found on the manufacturer website:

[www.wacosystem.com](http://www.wacosystem.com)

[www.softlink.cz](http://www.softlink.cz)

If interested in any additional information related to application of radio modules of WM868, WB169, WB868, or WS868 series or other manufacturer's equipment for telemetry and remote reading of consumption meters, feel free to contact the manufacturer:

**SOFTLINK s.r.o.**, Tomkova 409, 278 01 Kralupy nad Vltavou, Czech Republic

Phone.: +420 315 707 111, e-mail: [sales@softlink.cz](mailto:sales@softlink.cz), WEB: [www.softlink.cz](http://www.softlink.cz).